



Laser

Installation Instructions



IMPORTANT PLEASE READ BEFORE INSTALLATION

- Before commencing installation ensure the relevant mains supply has been safely isolated.
- Installation should be carried out in accordance with the latest relevant wiring regulations for the specific country/region.
- Installation should be carried out by a qualified electrician.
- Ensure all electrical connections are tight with no loose strands, including factory made connections.

WARNINGS

- Use only with the approved driver for this product.
- This luminaire is for indoor use only.
- **IMPORTANT** The LED driver must not be covered by ceiling insulation material; this will reduce the units operational lifetime, invalidate the guarantee and may cause a risk of fire.

This install manual covers the following products:

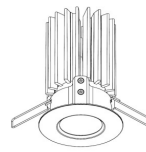

LR-F1-MW/xxx-xxx-xx-xx/xx

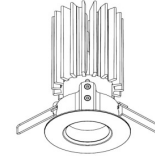

LR-FD-MW/xxx-xxx-xx-xx/xx

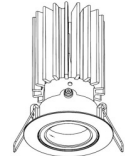

LR-AD-MW/xxx-xxx-xx-xx/xx

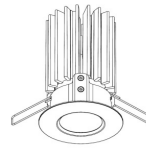

LR-FS-MW/xxx-xxx-xx-xx/xx

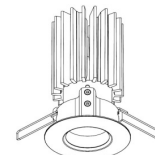

LR-DS-MW/xxx-xxx-xx-xx/xx

1.

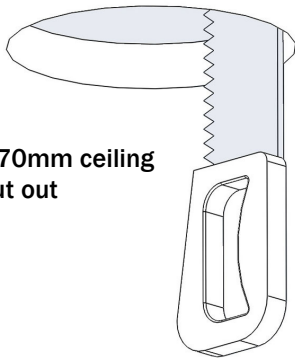

Ø70mm ceiling cut out

2.

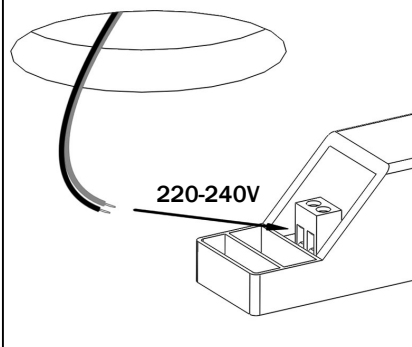

220-240V

3.

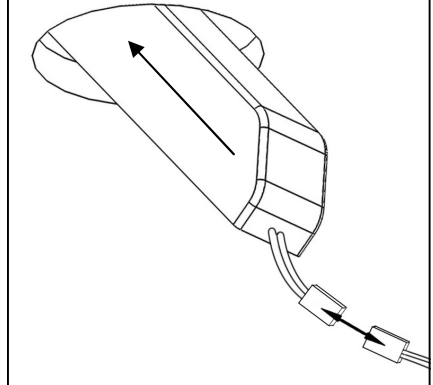

4.

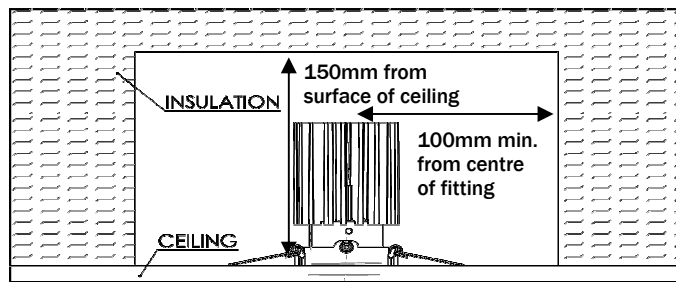
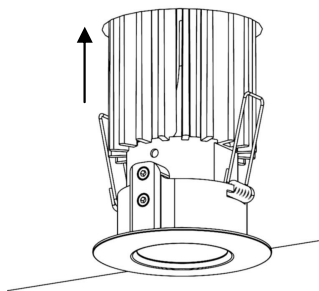

Diagram showing required airspace

Photonstar LED Ltd.
Unit 8, Westlink,
Belbins Business Park
Romsey
Hampshire
SO51 7JF
UK

Tel: +44(0) 2381 230 381
Email: info@photonstarled.co.uk
Web: www.photonstarlighting.com

