



# Ceiling Star Installation Instructions



## IMPORTANT PLEASE READ BEFORE INSTALLATION

- Before commencing installation ensure the relevant mains supply has been safely isolated.
- Installation should be carried out in accordance with the latest relevant wiring regulations for the specific country/region.
- Installation should be carried out by a qualified electrician.
- Ensure all electrical connections are tight with no loose strands, including factory made connections.

### WARNINGS

- Use only with the approved driver for this product.
- This luminaire is for indoor use only.
- **IMPORTANT** The LED driver must not be covered by ceiling insulation material; this will reduce the units operational lifetime, invalidate the guarantee and may cause a risk of fire.

This install manual covers the following products:

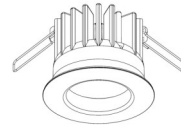

CS-DL-MW/xxx-xxx-xx-xx/xx

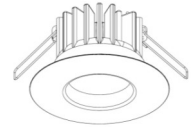

CS-TT-MW/xxx-xxx-xx-xx/xx

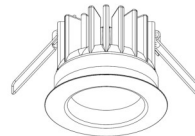

CS-TS-MW/xxx-xxx-xx-xx/xx

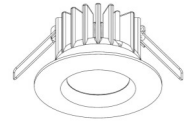

CS-ED-MW/xxx-xxx-xx-xx/xx  
CS-DB-MW/xxx-xxx-xx-xx/xx

1.

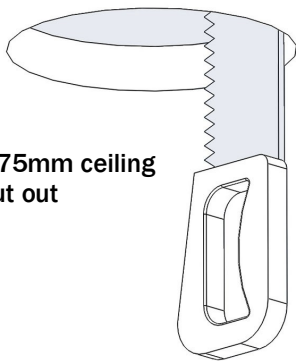

Ø75mm ceiling  
cut out

2.

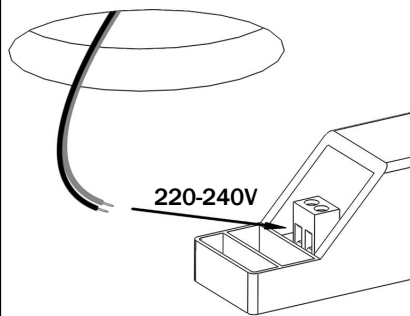

220-240V

3.

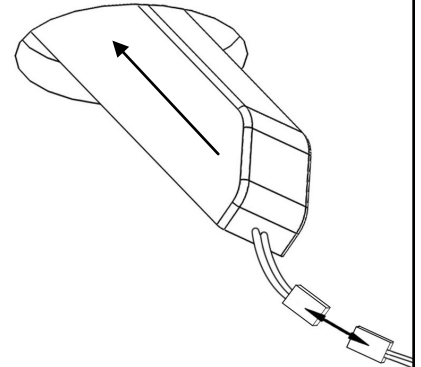

4.

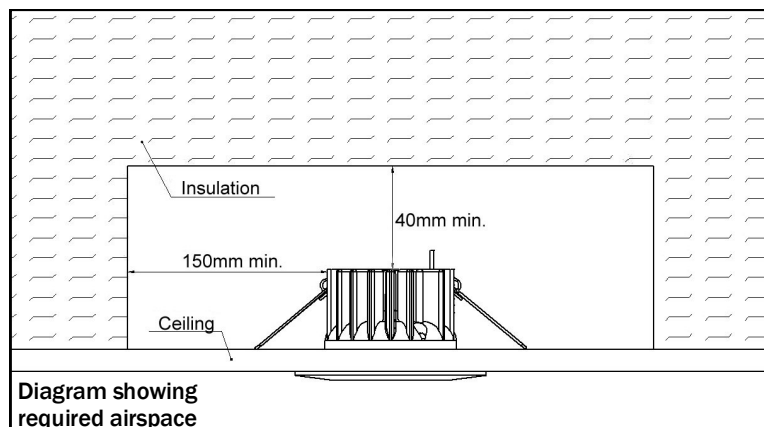
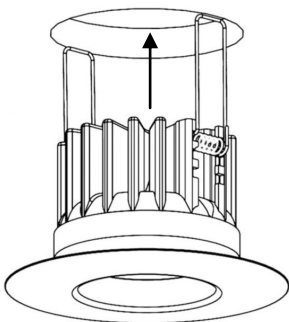

Diagram showing  
required airspace

Photonstar LED Ltd.  
Unit 8, Westlink,  
Belbins Business Park  
Romsey  
Hampshire  
SO51 7JF  
UK

Tel: +44(0) 2381 230 381  
Email: info@photonstarled.com  
Web: www.photonstarlighting.com

